

SPECIFICATION FOR APPROVAL

- () Preliminary Specification
 (◆) Final Specification

Title	15.6" W FHD TFT LCD
-------	---------------------

Customer	Dell
MODEL	

SUPPLIER	LG Display Co., Ltd.
*MODEL	LP156WF1
Suffix	TPB1

*When you obtain standard approval,
 please use the above model name without suffix

APPROVED BY	SIGNATURE
/	_____
/	_____
/	_____

Please return 1 copy for your confirmation with your signature and comments.

APPROVED BY	SIGNATURE
G. J. Kwon / S.Manager	_____
REVIEWED BY	
S. R. Kim / Manager	_____
PREPARED BY	
C. J. Park / Engineer	_____

Products Engineering Dept.
 LG Display Co., Ltd

Contents

No	ITEM	Page
	COVER	1
	CONTENTS	2
	RECORD OF REVISIONS	3
1	GENERAL DESCRIPTION	4
2	ABSOLUTE MAXIMUM RATINGS	5
3	ELECTRICAL SPECIFICATIONS	
3-1	ELECTRICAL CHARACTERISTICS	6
3-2	INTERFACE CONNECTIONS	8
3-3	eDP SIGNAL TIMING SPECIFICATION	9
3-4	SIGNAL TIMING SPECIFICATIONS	10
3-5	SIGNAL TIMING WAVEFORMS	10
3-6	COLOR INPUT DATA REFERENCE	11
3-7	POWER SEQUENCE	12
4	OPTICAL SPECIFICATIONS	13-15
5	MECHANICAL CHARACTERISTICS	16-19
6	RELIABILITY	23
7	INTERNATIONAL STANDARDS	
7-1	SAFETY	24
7-2	EMC	24
8	PACKING	
8-1	DESIGNATION OF LOT MARK	25
8-2	PACKING FORM	25
9	PRECAUTIONS	26-27
A	APPENDIX. Enhanced Extended Display Identification Data	28-30

Product Specification**RECORD OF REVISIONS**

Revision No	Revision Date	Page	Description	EDID ver
0.0	Jun. 17, 2009	All	First Draft (Preliminary Specification)	-
0.1	Oct. 17, 2009	19	Add PPID Label Revision Code	
0.2	Sep. 25, 2009	6-7	Update ELECTRICAL CHARACTERISTICS	
		8	Update Interface Connections symbol (NC → ML1-, ML1+)	
		14	Update Gray Scale (G55)	
0.3	Dec. 5, 2009	28-30	EDID Updated	X20
0.4	Jan. 21, 2010	4	Update General Description	
		6	Update Electrical Characteristics	
		10	Update Signal Specifications	
		18	Update Rear View	
1.0	Jan. 21, 2010	28-30	Update EDID	A00
		All	Final Specification	

Product Specification

1. General Description

The LP156WF1 is a Color Active Matrix Liquid Crystal Display with an integral LED backlight system. The matrix employs a-Si Thin Film Transistor as the active element. It is a transmissive type display operating in the normally white mode. This TFT-LCD has 15.6 inches diagonally measured active display area with FHD resolution (1080 vertical by 1920 horizontal pixel array). Each pixel is divided into Red, Green and Blue sub-pixels or dots which are arranged in vertical stripes. Gray scale or the brightness of the sub-pixel color is determined with a 6-bit gray scale signal for each dot, thus, presenting a palette of more than 262,144 colors.

The LP156WF1 has been designed to apply the interface method that enables low power, high speed, low EMI.

The LP156WF1 is intended to support applications where thin thickness, low power are critical factors and graphic displays are important. In combination with the vertical arrangement of the sub-pixels, the LP156WF1 characteristics provide an excellent flat display for office automation products such as Notebook PC.

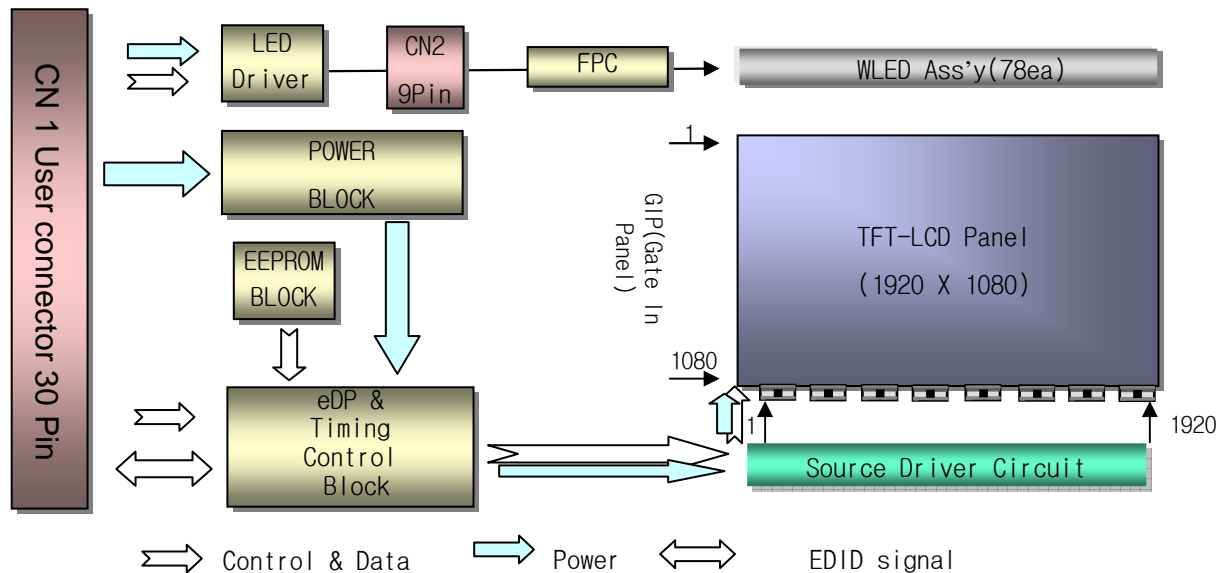

General Features

Active Screen Size	15.6 inches diagonal
Outline Dimension	359.3(H, typ.) × 209.5(V, typ.) × 5.7(D,max) [mm]
Pixel Pitch	0.17925 mm x 0.17925 mm
Pixel Format	1920 horiz. By 1080 vert. Pixels RGB strip arrangement
Color Depth	6-bit, 262,144 colors
Luminance, White	300 cd/m ² (Typ.5 point)
Power Consumption	Total 7.85W(Typ.) Logic : 2.0 W (Typ.@ Mosaic), B/L : 5.85W (Typ.@ VLED 12V)
Weight	470g (Max.)
Display Operating Mode	Transmissive mode, normally white
Surface Treatment	Anti-Glare treatment of the front polarizer(3H)
RoHS Comply	Yes
BFR / PVC / As Free	Yes all.

2. Absolute Maximum Ratings

The following are maximum values which, if exceeded, may cause faulty operation or damage to the unit.

Table 1. ABSOLUTE MAXIMUM RATINGS

Parameter	Symbol	Values		Units	Notes
		Min	Max		
Power Input Voltage	VCC	-0.3	4.0	Vdc	at 25 ± 5°C
Operating Temperature	TOP	0	50	°C	1
Storage Temperature	HST	-20	60	°C	1
Operating Ambient Humidity	HOP	10	90	%RH	1
Storage Humidity	HST	10	90	%RH	1

Note : 1. Temperature and relative humidity range are shown in the figure below.
Wet bulb temperature should be 39°C Max, and no condensation of water.

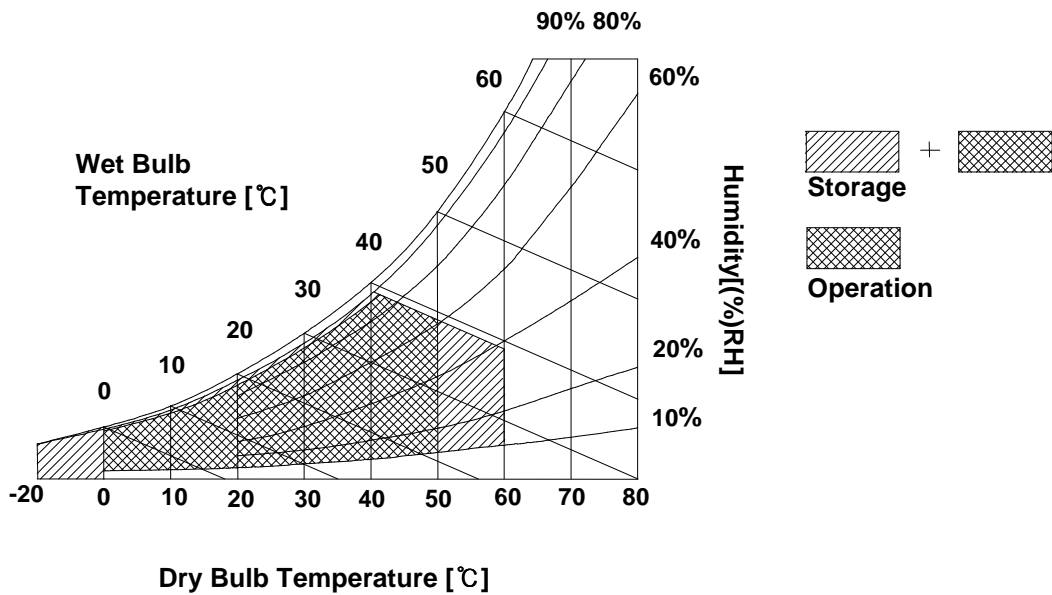

3. Electrical Specifications

3-1. Electrical Characteristics

The LP156WF1 requires two power inputs. The first logic is employed to power the LCD electronics and to drive the TFT array and liquid crystal. The second backlight is the input about LED BL with LED Driver.

Table 2. ELECTRICAL CHARACTERISTICS

Parameter	Symbol	Values			Unit	Notes
		Min	Typ	Max		
LOGIC :						
Power Supply Input Voltage	V _{CC}	3.0	3.3	3.6	V	1
Power Supply Input Current	I _{CC} Mosaic	-	600	700	mA	2
Power Consumption	P _{CC}	-	2.0	2.3	W	2
Power Supply Inrush Current	I _{CC_P}	-	-	1500	mA	3
LVDS Impedance	Z _{LVDS}	90	100	110	Ω	4
BACKLIGHT : (with LED Driver)						
LED Power Input Voltage	V _{LED}	7.0	12.0	21.0	V	5
LED Power Input Current	I _{LED}	-	487	517	mA	6
LED Power Consumption	P _{LED}	-	5.85	6.2	W	6
LED Power Inrush Current	I _{LED_P}	-	-	1500	mA	7
PWM Duty Ratio		5	-	100	%	8
PWM Jitter	-	0	-	0.2	%	9
PWM Impedance	Z _{PWM}	20	40	60	kΩ	
PWM Frequency	F _{PWM}	200	-	1000	Hz	10
PWM High Level Voltage	V _{PWM_H}	3.0	-	5.3	V	
PWM Low Level Voltage	V _{PWM_L}	0	-	0.5	V	
LED_EN Impedance	Z _{PWM}	20	40	60	kΩ	
LED_EN High Voltage	V _{LED_EN_H}	3.0	-	5.3	V	
LED_EN Low Voltage	V _{LED_EN_L}	0	-	0.5	V	
Life Time		12000	-	-	Hrs	11

Product Specification

Note)

1. The measuring position is the connector of LCM and the test conditions are under 25 °C , $f_v = 60\text{Hz}$, Black pattern.
2. The specified I_{cc} current and power consumption are under the $V_{cc} = 3.3\text{V}$, 25 °C , $f_v = 60\text{Hz}$ condition and Mosaic pattern.

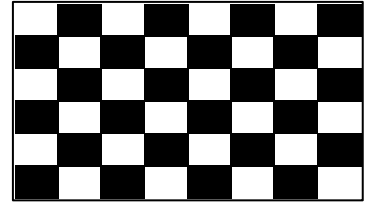

3. This Spec. is the max load condition for the cable impedance designing.
4. The below figures are the measuring V_{cc} condition and the V_{cc} control block LGD used.
The V_{cc} condition is same as the minimum of T1 at Power on sequence.

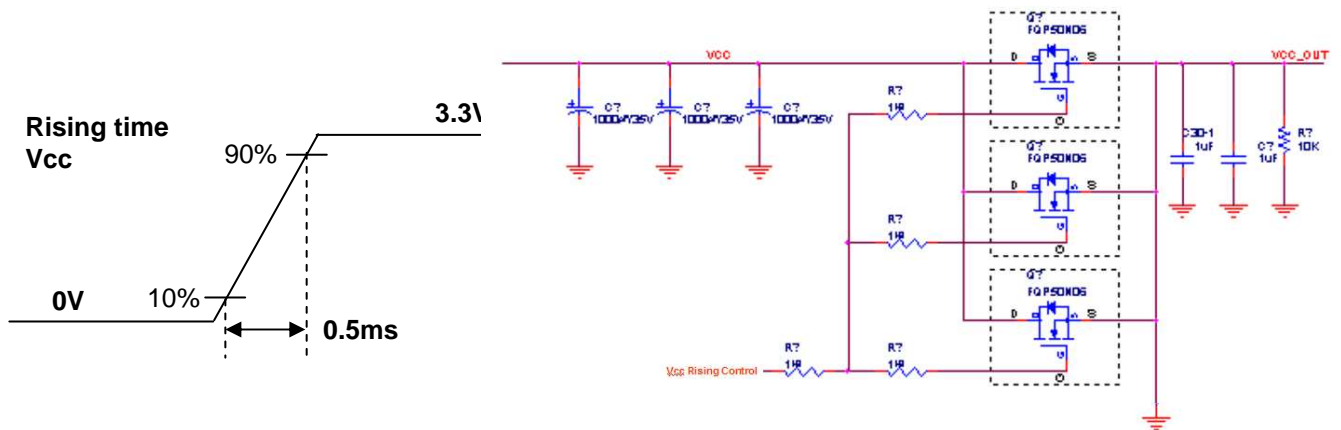

5. This impedance value is needed for proper display and measured from LVDS Tx to the mating connector.
6. The measuring position is the connector of LCM and the test conditions are under 25 °C .
7. The current and power consumption with LED Driver are under the $V_{led} = 12.0\text{V}$, 25 °C , Dimming of Max luminance and White pattern with the normal frame frequency operated(60Hz).
8. The below figures are the measuring V_{led} condition and the V_{led} control block LGD used.
 V_{LED} control block is same with V_{cc} control block.

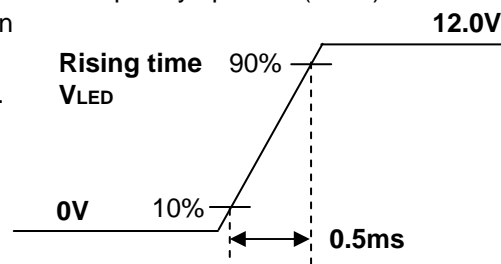

9. The operation of LED Driver below minimum dimming ratio may cause flickering or reliability issue.
10. If Jitter of PWM is bigger than maximum, it may induce flickering.
11. This Spec. is not effective at 100% dimming ratio as an exception because it has DC level equivalent to 0Hz. In spite of acceptable range as defined, the PWM Frequency should be fixed and stable for more consistent brightness control at any specific level desired.
12. The life time is determined as the time at which brightness of LCD is 50% compare to that of minimum value specified in table 7. under general user condition.

3-2. Interface Connections

This LCD employs two interface connections, a 30 pin connector is used for the module electronics interface and the other connector is used for the integral backlight system.

The electronics interface connector is a model CABLINE-VS RECE ASS'Y manufactured by I-PEX.

Table 3. MODULE CONNECTOR PIN CONFIGURATION (CN1)

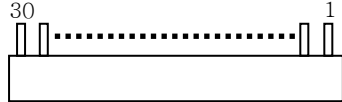
Pin	Symbol	Description	Notes
1	PAID	Conn. Continuity Test (Reserved)	
2	H_GND	High Speed (Main Link) Ground	1. Interface chips 1.1 LCD : IDT, Becrux (LCD Controller) including eDP Receiver 1.2 System : TBD or equivalent * Pin to Pin compatible with eDP 2. Connector 2.1 LCD : CABLINE-VS RECE ASS'Y, I-PEX or its compatibles 2.2 Mating : CABLINE-VS PLUG CABLE ASS'Y or equivalent. 2.3 Connector pin arrangement
3	ML1-	Complement Signal-Lane 1	
4	ML1+	True Signal-Main Lane 1	
5	H_GND	High Speed (Main Link) Ground	
6	ML0-	Complement Signal-Lane 0	
7	ML0+	True Signal-Main Lane 0	
8	H_GND	High Speed (Main Link) Ground	
9	AUX+	True Signal-Auxiliary Channel	
10	AUX-	Complement Signal-Auxiliary Channel	
11	H_GND	High Speed (Main Link) Ground	
12	VCC	VCC for Module (3.3V)	 <p>[LCD Module Rear View]</p>
13	VCC	VCC for Module (3.3V)	
14	BIST	Built-In Self Test (active high)	
15	GND	Ground	
16	GND	Ground	
17	HPD	HPD signal pin	
18	BL_GND	BL Ground	
19	BL_GND	BL Ground	
20	BL_GND	BL Ground	
21	BL_GND	BL Ground	
22	BL_EN	BL On/Off (On: 3.0~3.3V, Off: 0~0.5V) / NC (100K pull-up) / 5V tolerant	
23	BL_PWM	PWM for luminance control (200~1KHz, 3.3V, 6~100%, 0V=off) 5V tolerant	
24	NC	No Connection (Reserved)	
25	NC	No Connection (Reserved)	
26	VBL	BL Power 7V-20V	
27	VBL	BL Power 7V-20V	
28	VBL	BL Power 7V-20V	
29	VBL	BL Power 7V-20V	
30	PAID	Conn. Continuity Test (Reserved)	

3-3. eDP Signal Timing Specifications

3-3-1. DC Specification

The VESA Display Port related AC specification is compliant with the VESA Display Port Standard v1.1a.

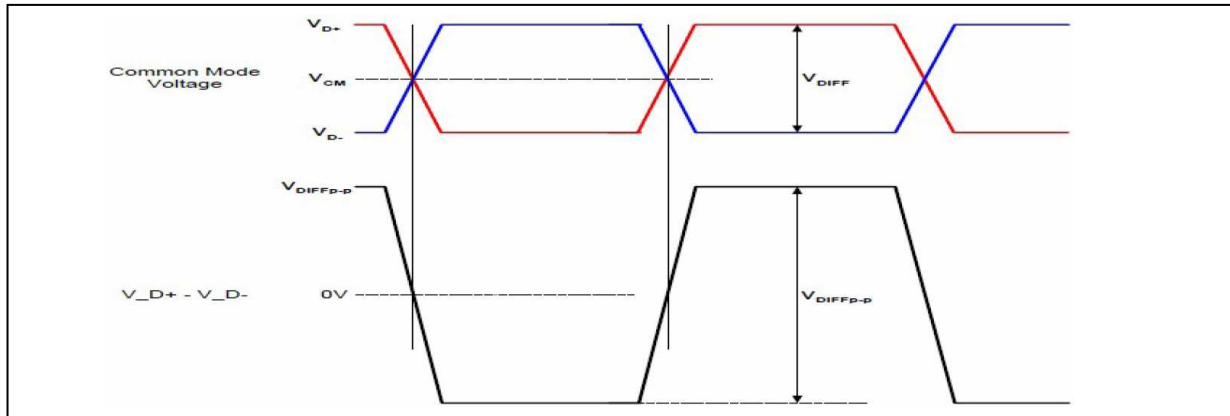

Description	Symbol	Min	Max	Unit	Notes
Differential peak-to-peak Input voltage	$V_{DIFF p-p}$	120	-	mV	For high bit rate
		40	-		For reduced bit rate
Rx DC common mode voltage	V_{CM}	0	2.0	V	-

3-3-2. AC Specification

The VESA Display Port related AC specification is compliant with the VESA Display Port Standard v1.1a.

Description	Symbol	Min	Typ	Max	Unit	Notes
Unit Interval for high bit rate (2.7Gbps/lane)	UI_High_Rate	-	370	-	ps	Range is nominal ± 350 ppm. DisplayPort Link Rx does not require local crystal for link clock generation
Unit Interval for high bit rate (1.62Gbps/lane)	UI_Low_Rate	-	617	-	ps	
Lane-to-Lane skew	V Rx-SKEW-INTER_PAIR	-	-	5200	ps	-
Lane intra-pair skew	V Rx-SKEW-INTRA_PAIR	-	-	100	ps	For high bit rate
		-	-	300	ps	For reduced bit rate

3-4. Signal Timing Specifications

This is the signal timing required at the input of the User connector. All of the interface signal timing should be satisfied with the following specifications and specifications of eDP Tx/Rx for its proper operation.

Table 4. TIMING TABLE

ITEM	Symbol	Min	Typ	Max	Unit	Note
DCLK	Frequency	f_{CLK}	-	137.7	-	MHz
Hsync	Period	t_{HP}	2020	2066	2156	tCLK
	Width	t_{WH}	32	32	32	
	Width-Active	t_{WHA}	1920	1920	1920	
Vsync	Period	t_{VP}	1096	1111	1122	tHP
	Width	t_{WV}	5	5	5	
	Width-Active	t_{WVA}	1080	1080	1080	
Data Enable	Horizontal back porch	t_{HBP}	48	66	100	tCLK
	Horizontal front porch	t_{HFP}	20	48	104	
	Vertical back porch	t_{VBP}	10	23	28	tHP
	Vertical front porch	t_{VFP}	1	3	9	

3-5. Signal Timing Waveforms

Condition : VCC =3.3V

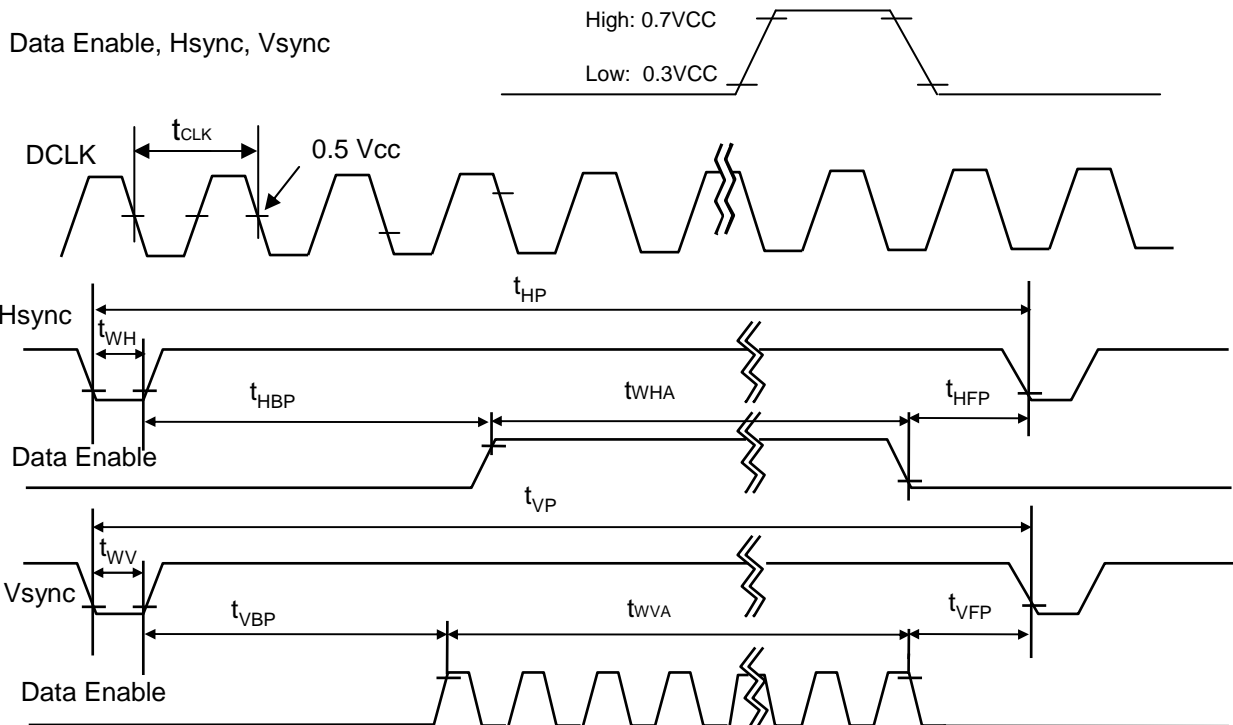

3-6. Color Input Data Reference

The brightness of each primary color (red, green and blue) is based on the 6-bit gray scale data input for the color ; the higher the binary input, the brighter the color. The table below provides a reference for color versus data input.

Table 5. COLOR DATA REFERENCE

Color		Input Color Data																	
		RED						GREEN						BLUE					
		MSB				LSB		MSB				LSB		MSB		LSB			
		R5	R4	R3	R2	R1	R0	G5	G4	G3	G2	G1	G0	B5	B4	B3	B2	B1	B0
Basic Color	Black	0	0	0	0	0	0	0	0	0	0	0	0	0	0	0	0	0	0
	Red	1	1	1	1	1	1	0	0	0	0	0	0	0	0	0	0	0	0
	Green	0	0	0	0	0	0	1	1	1	1	1	1	0	0	0	0	0	0
	Blue	0	0	0	0	0	0	0	0	0	0	0	0	1	1	1	1	1	1
	Cyan	0	0	0	0	0	0	1	1	1	1	1	1	1	1	1	1	1	1
	Magenta	1	1	1	1	1	1	0	0	0	0	0	0	1	1	1	1	1	1
	Yellow	1	1	1	1	1	1	1	1	1	1	1	1	0	0	0	0	0	0
	White	1	1	1	1	1	1	1	1	1	1	1	1	1	1	1	1	1	1
RED	RED (00)	0	0	0	0	0	0	0	0	0	0	0	0	0	0	0	0	0	0
	RED (01)	0	0	0	0	0	1	0	0	0	0	0	0	0	0	0	0	0	0
					
	RED (62)	1	1	1	1	1	0	0	0	0	0	0	0	0	0	0	0	0	0
	RED (63)	1	1	1	1	1	1	0	0	0	0	0	0	0	0	0	0	0	0
GREEN	GREEN (00)	0	0	0	0	0	0	0	0	0	0	0	0	0	0	0	0	0	0
	GREEN (01)	0	0	0	0	0	0	0	0	0	0	0	1	0	0	0	0	0	0
					
	GREEN (62)	0	0	0	0	0	0	1	1	1	1	1	0	0	0	0	0	0	0
	GREEN (63)	0	0	0	0	0	0	1	1	1	1	1	1	0	0	0	0	0	0
BLUE	BLUE (00)	0	0	0	0	0	0	0	0	0	0	0	0	0	0	0	0	0	0
	BLUE (01)	0	0	0	0	0	0	0	0	0	0	0	0	0	0	0	0	0	1
					
	BLUE (62)	0	0	0	0	0	0	0	0	0	0	0	0	1	1	1	1	1	0
	BLUE (63)	0	0	0	0	0	0	0	0	0	0	0	0	1	1	1	1	1	1

3-7. Power Sequence

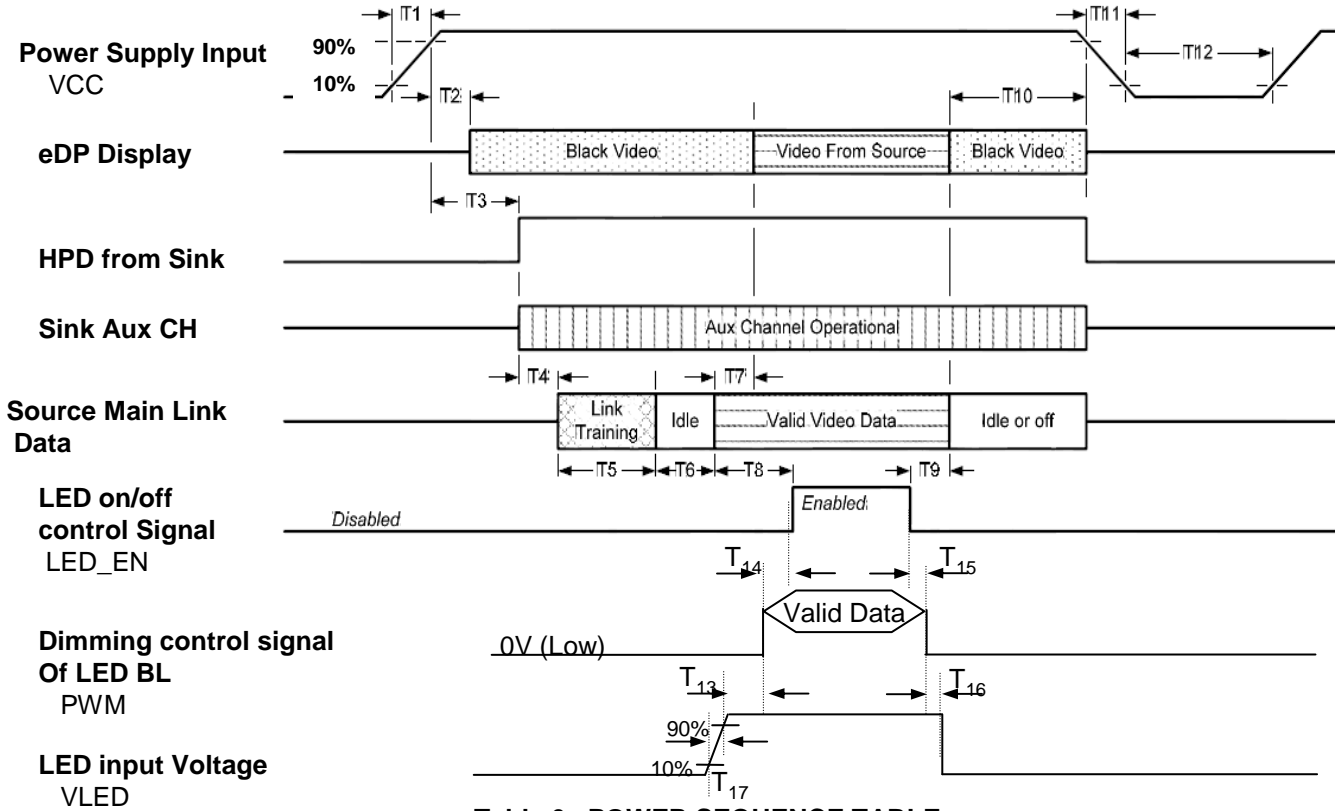

Table 6. POWER SEQUENCE TABLE

Parameter	Values			Units
	Min	Typ	Max	
T1	0.5	-	10	ms
T2	0	-	200	ms
T3	0	-	200	ms
T4	-	-	-	ms
T5	-	-	-	ms
T6	-	-	-	ms
T7	0	-	50	ms
T8	200	-	-	ms
T9	200	-	-	ms
T10	0	-	500	ms
T11	3	-	10	ms
T12	500	-	-	ms
T13	10	-	-	ms
T14	0	-	-	ms
T15	0	-	-	ms
T16	10	-	-	ms
T17	0.5	-	-	ms

Note)

1. Please avoid floating state of interface signal at invalid period.
2. When the interface signal is invalid, be sure to pull down the power supply for LCD VCC to 0V.
3. LED power must be turn on after power supply for LCD and interface signal are valid.

4. Optical Specification

Optical characteristics are determined after the unit has been 'ON' and stable for approximately 30 minutes in a dark environment at 25°C. The values specified are at an approximate distance 50cm from the LCD surface at a viewing angle of Φ and Θ equal to 0°.

FIG. 1 presents additional information concerning the measurement equipment and method.

FIG. 1 Optical Characteristic Measurement Equipment and Method

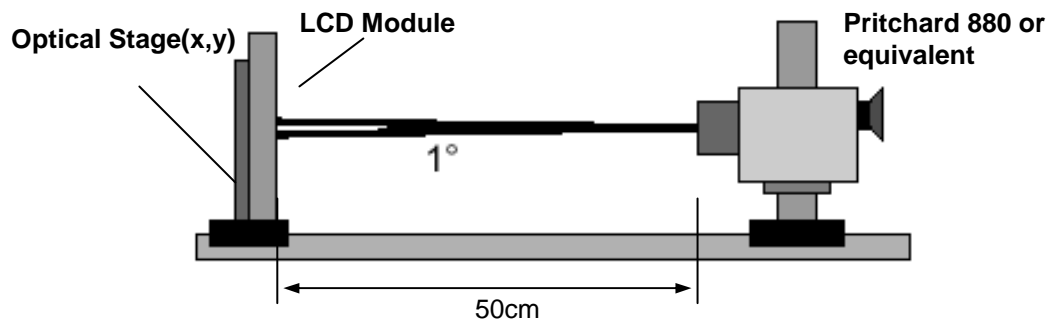

Table 8. OPTICAL CHARACTERISTICS

$T_a=25^\circ\text{C}$, $V_{CC}=3.3\text{V}$, $f_v=60\text{Hz}$, $f_{CLK}=137.7\text{MHz}$

Parameter	Symbol	Values			Units	Notes
		Min	Typ	Max		
Contrast Ratio	CR	500	-	-		1
Surface Luminance, white	L_{WH}	270	300	-	cd/m ²	2
Luminance Variation	δ_{WHITE}	-	1.4	1.6		3
Response Time	T_{R+T_D}	-	8	-	ms	4
Color Coordinates						
RED	RX	0.587	0.617	0.647		
	RY	0.319	0.349	0.379		
GREEN	GX	0.283	0.313	0.343		
	GY	0.565	0.595	0.625		
BLUE	BX	0.121	0.151	0.181		
	BY	0.026	0.056	0.086		
WHITE	WX	0.283	0.313	0.343		
	WY	0.299	0.329	0.359		
Viewing Angle						
x axis, right ($\Phi=0^\circ$)	Θ_r	60	-	-	degree	5
x axis, left ($\Phi=180^\circ$)	Θ_l	60	-	-	degree	
y axis, up ($\Phi=90^\circ$)	Θ_u	50	-	-	degree	
y axis, down ($\Phi=270^\circ$)	Θ_d	50	-	-	degree	
Gray Scale						6

Product Specification

Note)

1. Contrast Ratio(CR) is defined mathematically as

$$\text{Contrast Ratio} = \frac{\text{Surface Luminance with all white pixels}}{\text{Surface Luminance with all black pixels}}$$

2. Surface luminance is the average of 5 point across the LCD surface 50cm from the surface with all pixels displaying white. For more information see FIG 1.

$$L_{WH} = \text{Average}(L_1, L_2, \dots L_5)$$

3. The variation in surface luminance , The panel total variation (δ_{WHITE}) is determined by measuring L_N at each test position 1 through 13 and then defined as followed numerical formula.
For more information see FIG 2.

$$\delta_{WHITE} = \frac{\text{Maximum}(L_1, L_2, \dots L_{13})}{\text{Minimum}(L_1, L_2, \dots L_{13})}$$

4. Response time is the time required for the display to transition from white to black (rise time, Tr_R) and from black to white(Decay Time, Tr_D). For additional information see FIG 3.

5. Viewing angle is the angle at which the contrast ratio is greater than 10. The angles are determined for the horizontal or x axis and the vertical or y axis with respect to the z axis which is normal to the LCD surface. For more information see FIG 4.

6. Gray scale specification

* $f_V = 60\text{Hz}$

Gray Level	Luminance [%] (Typ)
L0	0
L7	1.00
L15	4.25
L23	10.90
L31	21.01
L39	34.82
L47	52.49
L55	74.17
L63	100

FIG. 2 Luminance

<measuring point for surface luminance & measuring point for luminance variation>

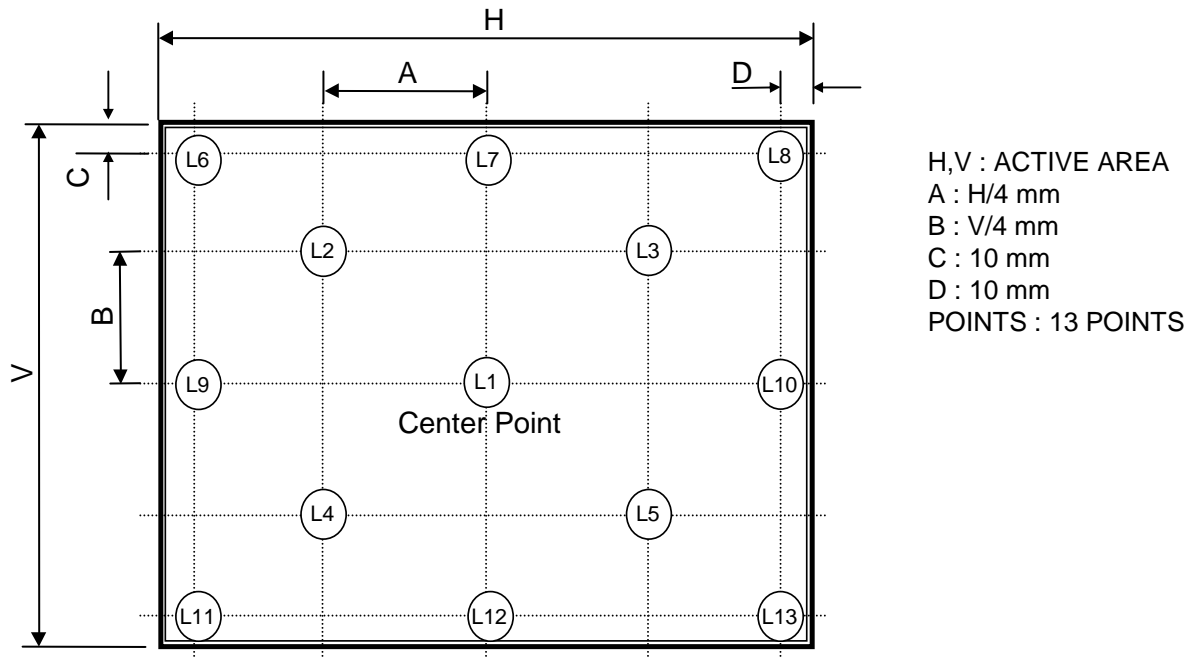
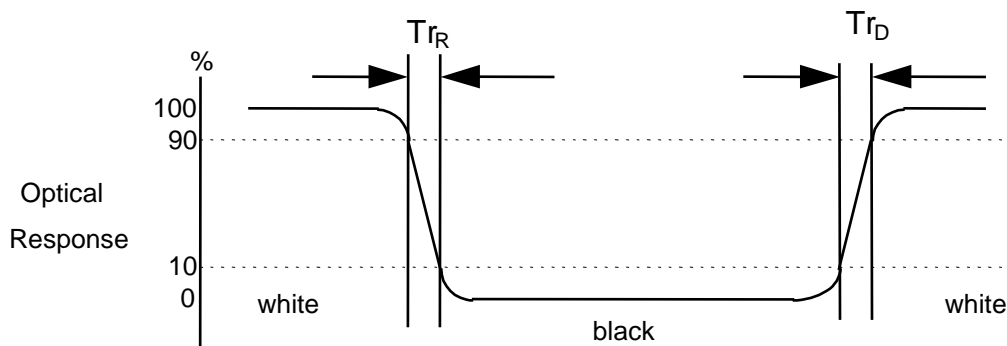

FIG. 3 Response Time

The response time is defined as the following figure and shall be measured by switching the input signal for “black” and “white”.



5. Mechanical Characteristics

The contents provide general mechanical characteristics for the model LP156WF1. In addition the figures in the next page are detailed mechanical drawing of the LCD.

Outline Dimension	Horizontal	$359.3 \pm 0.5\text{mm}$
	Vertical	$209.5 \pm 0.5\text{mm}$
	Thickness	5.7mm (max)
Bezel Area	Horizontal (VESA Standard)	$349.8 \pm 0.5\text{mm}$
	Vertical (VESA Standard)	$197.1 \pm 0.5\text{mm}$
Active Display Area	Horizontal	$344.16 \pm 0.3 \text{ mm}$
	Vertical	$193.59 \pm 0.3 \text{ mm}$
Weight	470g (Max.)	
Surface Treatment	Anti-Glare treatment of the front polarizer(3H)	

Product Specification

<FRONT VIEW>

Note) Unit:[mm], General tolerance: ± 0.5mm

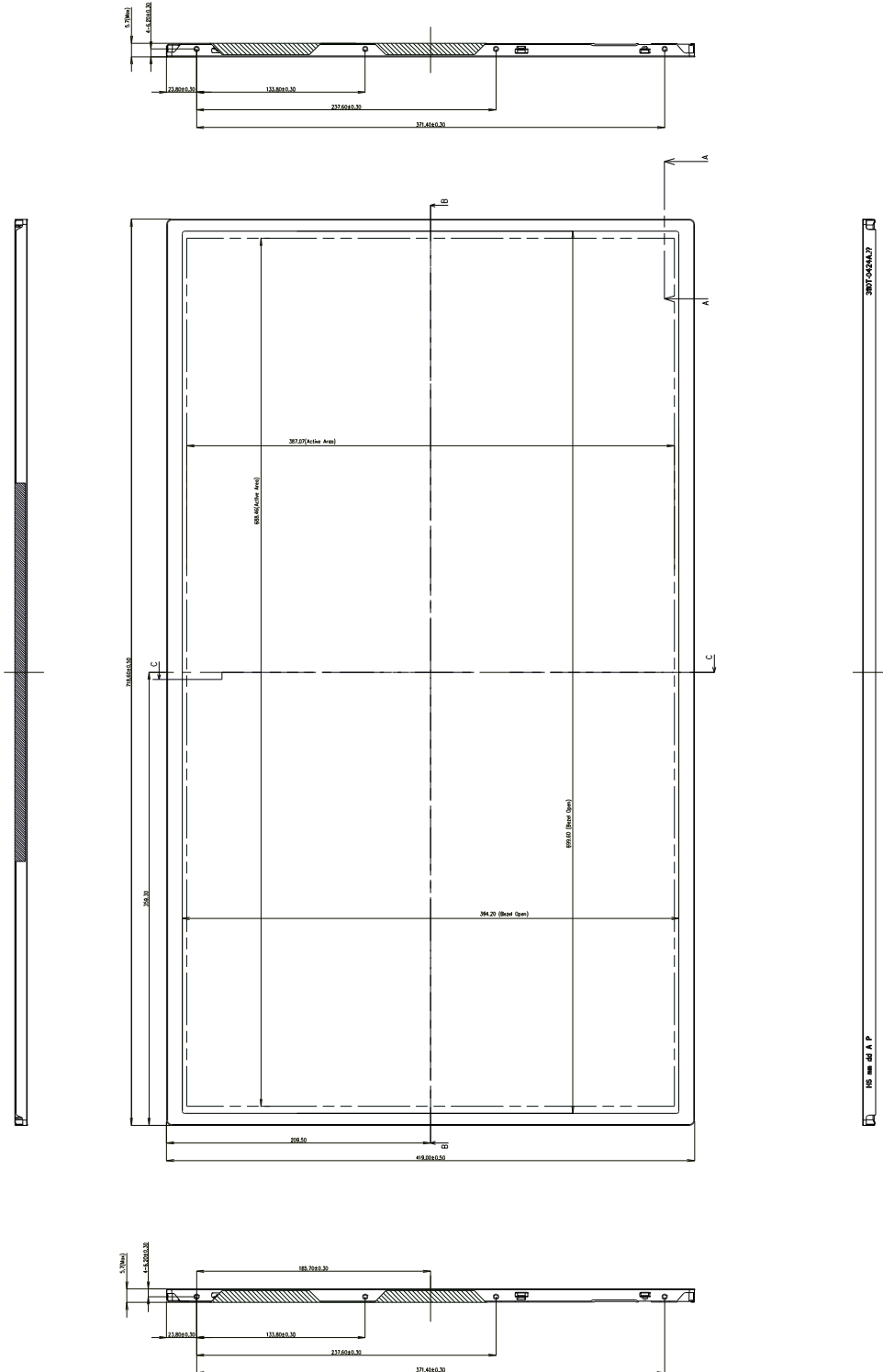

Product Specification

<REAR VIEW>

Note) Unit:[mm], General tolerance: ± 0.5mm

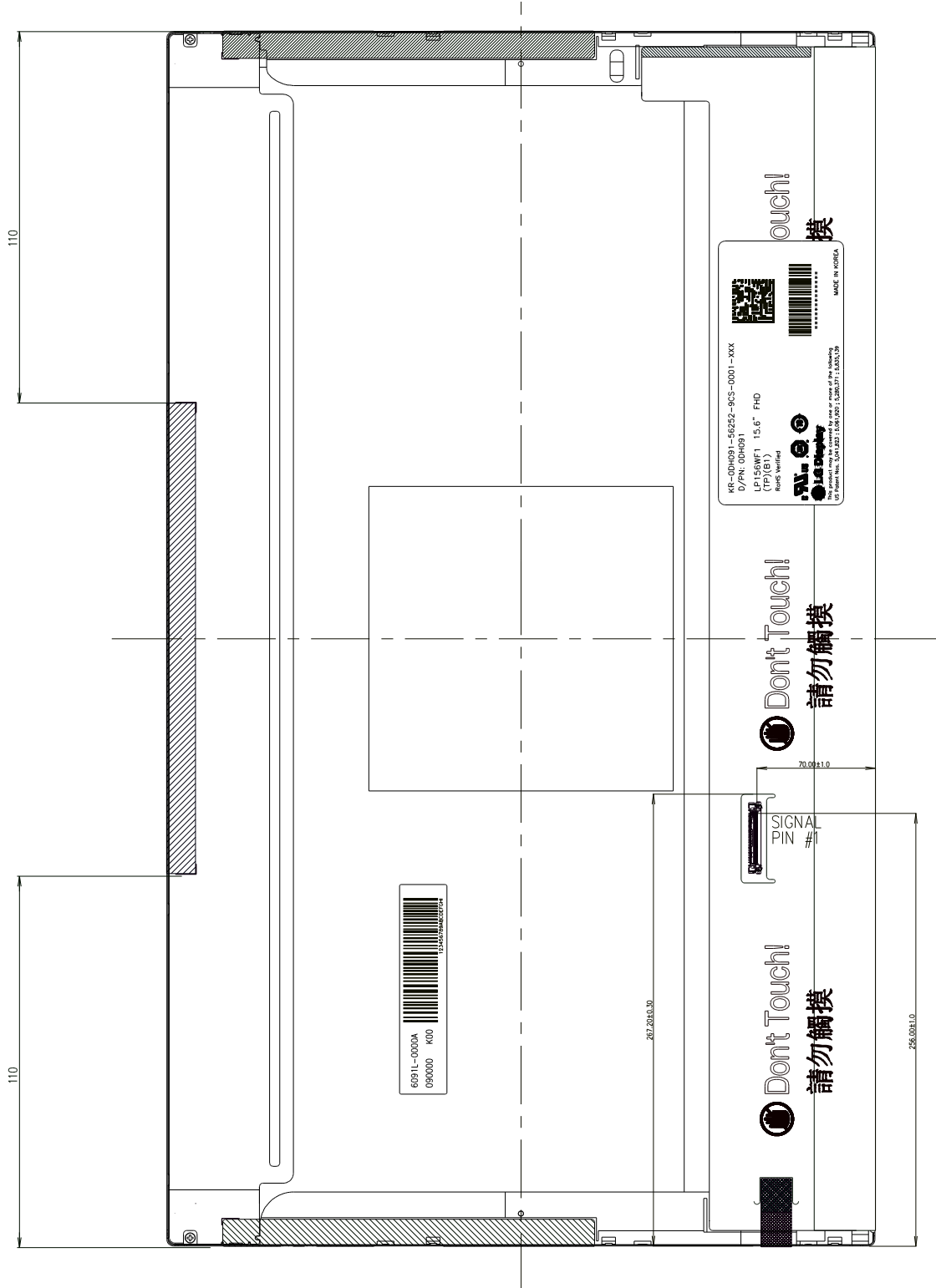

Product Specification

[DETAIL DESCRIPTION OF SIDE MOUNTING SCREW]

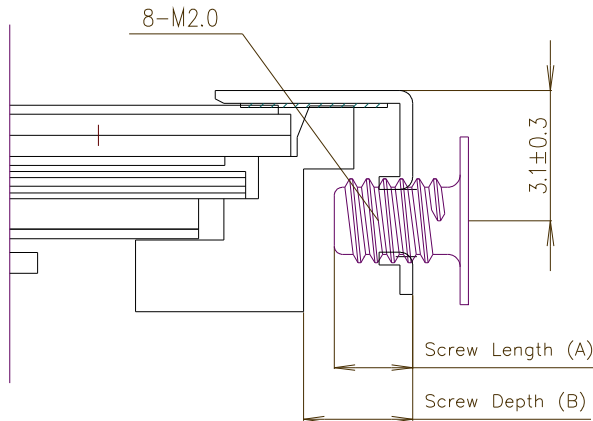

- * Mounting Screw Length (A)
= 2.0(Min) / 2.5(Max)
- * Mounting Screw Hole Depth (B)
= 2.5(Min)
- * Mounting hole location : 3.10(typ.)
- * Torque : 2.0 kgf.cm(Max)
(Measurement gauge : torque meter)

Notes : 1. Screw plated through the method of non-electrolytic nickel plating is preferred to reduce possibility that results in vertical and/or horizontal line defect due to the conductive particles from screw surface.

[DETAIL INFORMATION OF PPID LABEL AND REVISION CODE]

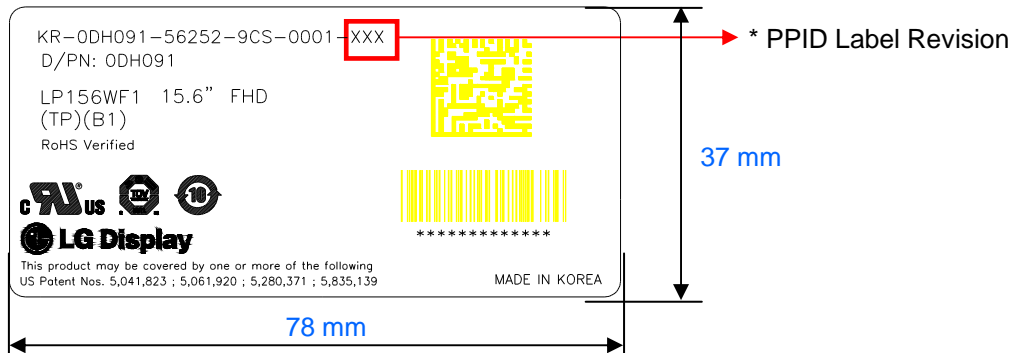

* PPID Label Revision :
It is subject to change with Dell event. Please refer to the below table for detail.

Classification	No Change	1st Revision	2nd Revision	...	9th Revision	...
SST(WS)	X00	X01	X02	...	A09	...
PT(ES)	X10	X11	X12	...	A19	...
ST(CS)	X20	X21	X22	...	A29	...
XB(MP)	A00	A01	A02	...	A09	...

LGD Proposal for system cover design.(Appendix)

1	Gap check for securing the enough gap between LCM and System cover.	
<p>The diagram illustrates the assembly of the LCM (Liquid Crystal Module) and the system cover. On the left, a top-down view of the LCM reflector side is shown with various components highlighted in green, purple, and yellow. To the right, a cross-sectional view shows the LCM being inserted into a housing. A double-headed arrow indicates the 'Max Thickness' of the LCM. A vertical dashed line marks 'A Boundary Line'. Three pink arrows point from the system cover towards the LCM, indicating potential contact or pressure. To the right of the housing, a blue rectangular block labeled 'Sponge' is shown, and a white outline represents the 'System Cover'.</p>		
Define	<p>1.Rear side of LCM is sensitive against external stress,and previous check about interference is highly needed.</p> <p>2.In case there is something from system cover comes into the boundary above,mechanical interference may cause the FOS defects. (Eg:Ripple,White spot..)</p>	
2	Check if antenna cable is sufficiently apart from T-CON of LCD Module.	
Define	<p>Two diagrams of a laptop illustrate the correct placement of the antenna cable. The left diagram, labeled 'NO GOOD', shows the antenna cable (red) overlapping the T-CON (black) area. The right diagram, labeled 'GOOD', shows the antenna cable (red) routed away from the T-CON area. Labels include 'Antenna' at the top, 'T-CON' in the center, and 'Antenna Cable' at the bottom of the display area.</p>	
1.If system antenna is overlapped with T-CON,it might be cause the noise.		

Product Specification

LGD Proposal for system cover design.

3	Gap check for securing the enough gap between LCM and System hinge.	
<p>LCM Reflector Side</p> <p>Side Mount Screw Hole (4ea)</p> <p>Hinge</p> <p>GAP: Min2.0mm</p> <p>COF (D-IC)</p> <p>("I" TYPE)</p> <p>("L" TYPE)</p>		
Define	<p>1. At least 2.0mm of gap needs to be secured to prevent the shock related defects.</p> <p>2. "L" type of hinge is recommended than "I" type under shock test.</p>	
4	Checking the path of the System wire.	
<p>LCM Reflector Side</p> <p>Ok</p> <p>Bad</p> <p>Good</p>		
Define	<p>1. COF area needs to be handled with care.</p> <p>2. GOOD → Wire path design to system side. OK → Wire path is located between COFs. BAD → Wire path overlapped with COF area.</p>	

LGD Proposal for system cover design.

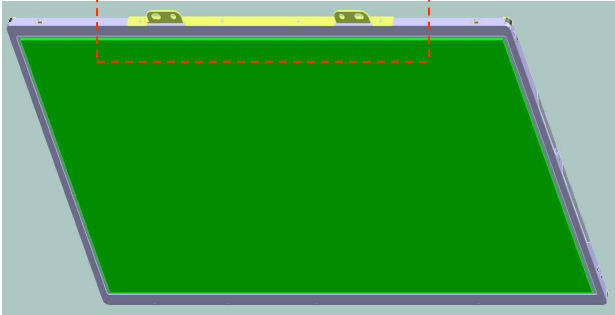
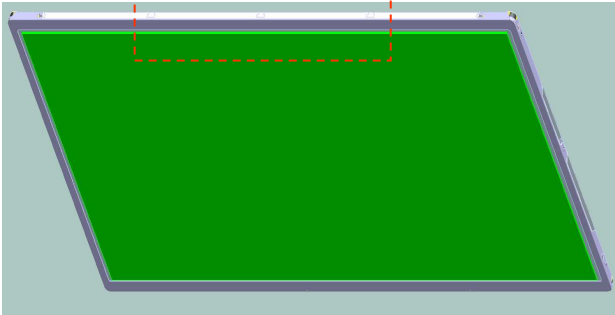
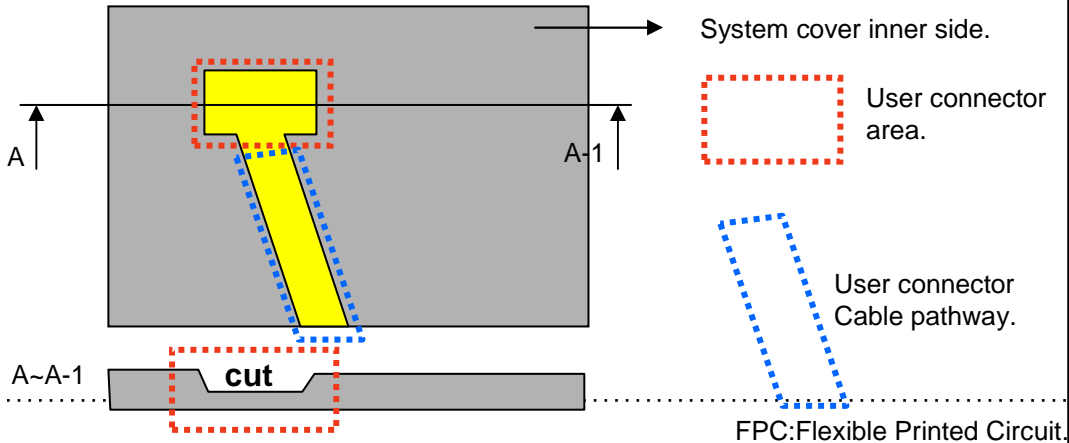
5	Using a bracket on the top of LCM is not recommended.
 <p style="text-align: center;">bracket</p> <div style="display: flex; justify-content: space-around;"> <div style="text-align: center;">  <p>With bracket</p> </div> <div style="text-align: center;">  <p>Without bracket</p> </div> </div>	
Define	<p>1.Condition without bracket is good for mechanical noise,and can minimize the light leakage from deformation of bracket.</p> <p>2.The results shows that there is no difference between the condition with or without bracket.</p>
6	Securing additional gap on CNT area..
 <p style="text-align: right;">System cover inner side.</p> <p style="text-align: right;">User connector area.</p> <p style="text-align: right;">User connector Cable pathway.</p> <p style="text-align: right;">FPC:Flexible Printed Circuit.</p>	
Define	<p>1.CNT area is specially sensitive against external stress,and additional gap by cutting on system cover will be helpful on removing the Ripple.</p> <p>2.Using a thinner CNT will be better. (eg: FPC type)</p>

6. Reliability

Environment test condition

No.	Test Item	Conditions
1	High temperature storage test	Ta= 60°C, 240h
2	Low temperature storage test	Ta= -20°C, 240h
3	High temperature operation test	Ta= 50°C, 50%RH, 240h
4	Low temperature operation test	Ta= 0°C, 240h
5	Vibration test (non-operating)	Sine wave, 10 ~ 500 ~ 10Hz, 1.5G, 0.37oct/min 3 axis, 1hour/axis
6	Shock test (non-operating)	Half sine wave, 180G, 2ms one shock of each six faces(I.e. run 180G 2ms for all six faces)
7	Altitude operating storage / shipment	0 ~ 10,000 feet (3,048m) 24Hr 0 ~ 40,000 feet (12,192m) 24Hr

{ Result Evaluation Criteria }

There should be no change which might affect the practical display function when the display quality test is conducted under normal operating condition.

7. International Standards

7-1. Safety

- a) UL 60950-1:2003, First Edition, Underwriters Laboratories, Inc., Standard for Safety of Information Technology Equipment.
- b) CAN/CSA C22.2, No. 60950-1-03 1st Ed. April 1, 2003, Canadian Standards Association, Standard for Safety of Information Technology Equipment.
- c) EN 60950-1:2001, First Edition, European Committee for Electrotechnical Standardization(CENELEC) European Standard for Safety of Information Technology Equipment.

7-2. EMC

- a) ANSI C63.4 "Methods of Measurement of Radio-Noise Emissions from Low-Voltage Electrical and Electrical Equipment in the Range of 9kHz to 40GHz." American National Standards Institute(ANSI), 1992
- b) C.I.S.P.R "Limits and Methods of Measurement of Radio Interface Characteristics of Information Technology Equipment." International Special Committee on Radio Interference.
- c) EN 55022 "Limits and Methods of Measurement of Radio Interface Characteristics of Information Technology Equipment." European Committee for Electrotechnical Standardization.(CENELEC), 1998 (Including A1: 2000)

8. Packing

8-1. Designation of Lot Mark

a) Lot Mark

A	B	C	D	E	F	G	H	I	J	K	L	M
---	---	---	---	---	---	---	---	---	---	---	---	---

A,B,C : SIZE(INCH)
 E : MONTH

D : YEAR
 F ~ M : SERIAL NO.

Note

1. YEAR

Year	2001	2002	2003	2004	2005	2006	2007	2008	2009	2010
Mark	1	2	3	4	5	6	7	8	9	0

2. MONTH

Month	Jan	Feb	Mar	Apr	May	Jun	Jul	Aug	Sep	Oct	Nov	Dec
Mark	1	2	3	4	5	6	7	8	9	A	B	C

b) Location of Lot Mark

Serial No. is printed on the label. The label is attached to the backside of the LCD module.
 This is subject to change without prior notice.

8-2. Packing Form

a) Package quantity in one box : 20 pcs

b) Box Size : 482 x 390 x 275

9. PRECAUTIONS

Please pay attention to the followings when you use this TFT LCD module.

9-1. MOUNTING PRECAUTIONS

- (1) You must mount a module using holes arranged in four corners or four sides.
- (2) You should consider the mounting structure so that uneven force (ex. Twisted stress) is not applied to the module. And the case on which a module is mounted should have sufficient strength so that external force is not transmitted directly to the module.
- (3) Please attach the surface transparent protective plate to the surface in order to protect the polarizer. Transparent protective plate should have sufficient strength in order to resist external force.
- (4) You should adopt radiation structure to satisfy the temperature specification.
- (5) Acetic acid type and chlorine type materials for the cover case are not desirable because the former generates corrosive gas of attacking the polarizer at high temperature and the latter causes circuit break by electro-chemical reaction.
- (6) Do not touch, push or rub the exposed polarizers with glass, tweezers or anything harder than HB pencil lead. And please do not rub with dust clothes with chemical treatment. Do not touch the surface of polarizer for bare hand or greasy cloth. (Some cosmetics are detrimental to the polarizer.)
- (7) When the surface becomes dusty, please wipe gently with absorbent cotton or other soft materials like chamois soaks with petroleum benzene. Normal-hexane is recommended for cleaning the adhesives used to attach front / rear polarizers. Do not use acetone, toluene and alcohol because they cause chemical damage to the polarizer.
- (8) Wipe off saliva or water drops as soon as possible. Their long time contact with polarizer causes deformations and color fading.
- (9) Do not open the case because inside circuits do not have sufficient strength.

9-2. OPERATING PRECAUTIONS

- (1) The spike noise causes the mis-operation of circuits. It should be lower than following voltage :
 $V = \pm 200\text{mV}$ (Over and under shoot voltage)
- (2) Response time depends on the temperature. (In lower temperature, it becomes longer.)
- (3) Brightness depends on the temperature. (In lower temperature, it becomes lower.)
And in lower temperature, response time (required time that brightness is stable after turned on) becomes longer.
- (4) Be careful for condensation at sudden temperature change. Condensation makes damage to polarizer or electrical contacted parts. And after fading condensation, smear or spot will occur.
- (5) When fixed patterns are displayed for a long time, remnant image is likely to occur.
- (6) Module has high frequency circuits. Sufficient suppression to the electromagnetic interference shall be done by system manufacturers. Grounding and shielding methods may be important to minimize the interference.

9-3. ELECTROSTATIC DISCHARGE CONTROL

Since a module is composed of electronic circuits, it is not strong to electrostatic discharge. Make certain that treatment persons are connected to ground through wrist band etc. And don't touch interface pin directly.

9-4. PRECAUTIONS FOR STRONG LIGHT EXPOSURE

Strong light exposure causes degradation of polarizer and color filter.

9-5. STORAGE

When storing modules as spares for a long time, the following precautions are necessary.

- (1) Store them in a dark place. Do not expose the module to sunlight or fluorescent light. Keep the temperature between 5°C and 35°C at normal humidity.
- (2) The polarizer surface should not come in contact with any other object.
It is recommended that they be stored in the container in which they were shipped.

9-6. HANDLING PRECAUTIONS FOR PROTECTION FILM

- (1) When the protection film is peeled off, static electricity is generated between the film and polarizer.
This should be peeled off slowly and carefully by people who are electrically grounded and with well ion-blown equipment or in such a condition, etc.
- (2) The protection film is attached to the polarizer with a small amount of glue. If some stress is applied to rub the protection film against the polarizer during the time you peel off the film, the glue is apt to remain on the polarizer.
Please carefully peel off the protection film without rubbing it against the polarizer.
- (3) When the module with protection film attached is stored for a long time, sometimes there remains a very small amount of glue still on the polarizer after the protection film is peeled off.
- (4) You can remove the glue easily. When the glue remains on the polarizer surface or its vestige is recognized, please wipe them off with absorbent cotton waste or other soft material like chamois soaked with normal-hexane.

Product Specification

APPENDIX A. Enhanced Extended Display Identification Data (EEDID™) 1/3

	Byte (Dec)	Byte (Hex)	Field Name and Comments	Value (Hex)	Value (Bin)
Header	0	00	Header	00	00000000
	1	01	Header	FF	11111111
	2	02	Header	FF	11111111
	3	03	Header	FF	11111111
	4	04	Header	FF	11111111
	5	05	Header	FF	11111111
	6	06	Header	FF	11111111
	7	07	Header	00	00000000
Vendor / Product	8	08	ID Manufacture Name LGD	30	00110000
	9	09	ID Manufacture Name	E4	11100100
	10	0A	ID Product Code 0000h	00	00000000
	11	0B	(Hex. LSB first)	00	00000000
	12	0C	ID Serial No. - Optional ("00h" If not used, Number Only and LSB First)	00	00000000
	13	0D	ID Serial No. - Optional ("00h" If not used, Number Only and LSB First)	00	00000000
	14	0E	ID Serial No. - Optional ("00h" If not used, Number Only and LSB First)	00	00000000
	15	0F	ID Serial No. - Optional ("00h" If not used, Number Only and LSB First)	00	00000000
	16	10	Week of Manufacture - Optinal 00 weeks	00	00000000
	17	11	Year of Manufacture 2009 years	13	00010011
18	12	EDID structure version # = 1	01	00000001	
19	13	EDID revision # = 4	04	00000100	
Display	20	14	Video input Definition = Input is a Digital Video signal Interface , Colo Bit Depth : 6 Bits per Primary Color , Digital Video Interface Standard Supported: DisplayPort is supported	95	10010101
	21	15	Horizontal Screen Size (Rounded cm) = 34 cm	22	00100010
	22	16	Vertical Screen Size (Rounded cm) = 19 cm	13	00010011
	23	17	Display Transfer Characteristic (Gamma) = (gamma*100)-100 = Example:(2.2*100)-100=120 = 2.2 Gamma	78	01111000
	24	18	Feature Support [Display Power Management(DPM) : Standby Mode is not supported, Suspend Mode is not supported, Active Off = Very Low Power is not supported ,Supported Color Encoding Formats : RGB 4:4:4 ,Other Feature Support Flags : No_sRGB, Preferred Timing Mode, No_Display is continuous frequency (Multi-mode_Base EDID and Extension Block).]	02	00000010
Vendor / Product	25	19	Red/Green Low Bits (RxRy/GxGy)	15	00010101
	26	1A	Blue/White Low Bits (BxBY/WxWy)	D5	11010101
	27	1B	Red X Rx = 0.617	9E	10011110
	28	1C	Red Y Ry = 0.349	59	01011001
	29	1D	Green X Gx = 0.313	50	01010000
	30	1E	Green Y Gy = 0.595	98	10011000
	31	1F	Blue X Bx = 0.151	26	00100110
	32	20	Blue Y By = 0.056	0E	00001110
	33	21	White X Wx = 0.313	50	01010000
34	22	White Y Wy = 0.329	54	01010100	
Established	35	23	Established timing 1 (Optional_00h if not used)	00	00000000
	36	24	Established timing 2 (Optional_00h if not used)	00	00000000
	37	25	Manufacturer's timings (Optional_00h if not used)	00	00000000
Standard Timing ID	38	26	Standard timing ID1 (Optional_01h if not used)	01	00000001
	39	27	Standard timing ID1 (Optional_01h if not used)	01	00000001
	40	28	Standard timing ID2 (Optional_01h if not used)	01	00000001
	41	29	Standard timing ID2 (Optional_01h if not used)	01	00000001
	42	2A	Standard timing ID3 (Optional_01h if not used)	01	00000001
	43	2B	Standard timing ID3 (Optional_01h if not used)	01	00000001
	44	2C	Standard timing ID4 (Optional_01h if not used)	01	00000001
	45	2D	Standard timing ID4 (Optional_01h if not used)	01	00000001
	46	2E	Standard timing ID5 (Optional_01h if not used)	01	00000001
	47	2F	Standard timing ID5 (Optional_01h if not used)	01	00000001
	48	30	Standard timing ID6 (Optional_01h if not used)	01	00000001
	49	31	Standard timing ID6 (Optional_01h if not used)	01	00000001
	50	32	Standard timing ID7 (Optional_01h if not used)	01	00000001
	51	33	Standard timing ID7 (Optional_01h if not used)	01	00000001
	52	34	Standard timing ID8 (Optional_01h if not used)	01	00000001
	53	35	Standard timing ID8 (Optional_01h if not used)	01	00000001

Product Specification

APPENDIX A. Enhanced Extended Display Identification Data (EEDID™) 2/3

	Byte (Dec)	Byte (Hex)	Field Name and Comments	Value (Hex)	Value (Bin)	
Timing Descriptor #1	54	36	Pixel Clock/10,000 (LSB) 137.7 MHz @ 60Hz	CA	11001010	
	55	37	Pixel Clock/10,000 (MSB)	35	00110101	
	56	38	Horizontal Active (HA) (lower 8 bits) 1920 Pixels	80	10000000	
	57	39	Horizontal Blanking (HB) (lower 8 bits) 146 Pixels	92	10010010	
	58	3A	Horizontal Active / Horizontal Blanking(HA HB) (upper 4:4bits)	70	01110000	
	59	3B	Vertical Active (VA) 1080 Lines	38	00111000	
	60	3C	Vertical Blanking (VB) (DE Blanking typ.for DE only panels) 31 Lines	1F	00011111	
	61	3D	Vertical Active / Vertical Blanking (VA VB) (upper 4:4bits)	40	01000000	
	62	3E	Horizontal Front Porch in pixels (HF) (lower 8 bits)48 Pixels	30	00110000	
	63	3F	Horizontal Sync Pulse Width in pixels (HS) (lower 8 bits) 32 Pixels	20	00100000	
	64	40	Vertical Front Porch in lines (VF) (lower 4 bits) : Vertical Sync Pluse Width in lines (VS) (lower 4 bits)	35	00110101	
	65	41	Horizontal Front Porch/ Sync Pulse Width/ Vertical Front Porch/ Sync Pulse Width (upper 2bits)	00	00000000	
	66	42	Horizontal Vedio Image Size (mm) (lower 8 bits) 344 mm	58	01011000	
	67	43	Vertical Vedio Image Size (mm) (lower 8 bits) 194 mm	C2	11000010	
	68	44	Horizontal Image Size / Vertical Image Size (upper 4 bits)	10	00010000	
	69	45	Horizontal Border = 0 (Zero for Notebook LCD)	00	00000000	
	70	46	Vertical Border = 0 (Zero for Notebook LCD)	00	00000000	
	71	47	Non-Interlace, Normal display, no stereo, Digital Separate [Vsync_NEG, Hsync_NEG (outside of V-sync)]	18	00011000	
	Timing Descriptor #2	72	48	Pixel Clock/10,000 (LSB) 92.5 MHz @ 40Hz	22	00100010
		73	49	Pixel Clock/10,000 (MSB)	24	00100100
		74	4A	Horizontal Active (HA) (lower 8 bits) 1920 Pixels	80	10000000
75		4B	Horizontal Blanking (HB) (lower 8 bits) 160 Pixels	A0	10100000	
76		4C	Horizontal Active / Horizontal Blanking(HA HB) (upper 4:4bits)	70	01110000	
77		4D	Vertical Active (VA) 1080 Lines	38	00111000	
78		4E	Vertical Blanking (VB) (DE Blanking typ.for DE only panels) 31 Lines	1F	00011111	
79		4F	Vertical Active / Vertical Blanking (VA VB) (upper 4:4bits)	40	01000000	
80		50	Horizontal Front Porch in pixels (HF) (lower 8 bits)48 Pixels	30	00110000	
81		51	Horizontal Sync Pulse Width in pixels (HS) (lower 8 bits) 32 Pixels	20	00100000	
82		52	Vertical Front Porch in lines (VF) (lower 4 bits) : Vertical Sync Pluse Width in lines (VS) (lower 4 bits)	35	00110101	
83		53	Horizontal Front Porch/ Sync Pulse Width/ Vertical Front Porch/ Sync Pulse Width (upper 2bits)	00	00000000	
84		54	Horizontal Vedio Image Size (mm) (lower 8 bits) 344 mm	58	01011000	
85		55	Vertical Vedio Image Size (mm) (lower 8 bits) 194 mm	C2	11000010	
86		56	Horizontal Image Size / Vertical Image Size (upper 4 bits)	10	00010000	
87		57	Horizontal Border = 0 (Zero for Notebook LCD)	00	00000000	
88		58	Vertical Border = 0 (Zero for Notebook LCD)	00	00000000	
89		59	Non-Interlace, Normal display, no stereo, Digital Separate [Vsync_NEG, Hsync_NEG (outside of V-sync)]	18	00011000	
Timing Descriptor #3	90	5A	Flag	00	00000000	
	91	5B	Flag	00	00000000	
	92	5C	Flag	00	00000000	
	93	5D	Data Type Tag : Alphanumeric Data String (ASCII String)	FE	11111110	
	94	5E	Flag	00	00000000	
	95	5F	Dell P/N 1st Character = D	44	01000100	
	96	60	Dell P/N 2nd Character = H	48	01001000	
	97	61	Dell P/N 3rd Character = 0	30	00110000	
	98	62	Dell P/N 4th Character = 9	39	00111001	
	99	63	Dell P/N 5th Character = 1	31	00110001	
	100	64	EDID Revision Build Name = MP(X-Build) , Revision # = A00	80	10000000	
	101	65	Manufacturer P/N = 1	31	00110001	
	102	66	Manufacturer P/N = 5	35	00110101	
	103	67	Manufacturer P/N = 6	36	00110110	
	104	68	Manufacturer P/N = W	57	01010111	
	105	69	Manufacturer P/N = F	46	01000110	
	106	6A	Manufacturer P/N = 1	31	00110001	
	107	6B	Manufacturer P/N (If < 13 char, then terminate with ASC II code 0Ah,set re	00	00000000	

Product Specification

APPENDIX A. Enhanced Extended Display Identification Data (EEDID™) 3/3

	Byte (Dec)	Byte (Hex)	Field Name and Comments	Value (Hex)	Value (Bin)
Timing Descriptor #4	108	6C	Flag	00	00000000
	109	6D	Flag	00	00000000
	110	6E	Flag	00	00000000
	111	6F	Data Type Tag : Descriptor Defined by manufacturer	00	00000000
	112	70	Flag	00	00000000
	113	71	Color Management [No +2 FRC Support, True Color Depth : 6 bit]	00	00000000
	114	72	Panel Type [WLED] , Configuration [Single light bar], Number Lamp or LED Light Bar [one]	41	01000001
	115	73	Frame Rate Details [Minimum Frame Rate : 40Hz, Maximum Frame Rate : 65Hz , Tcon provides native Intel DRRS / sDRRS support]	31	00110001
	116	74	Controller Interface and Maximum Luminance [SMBUS type, 300 nit]	1E	00011110
	117	75	Front Surface / Polarizer [Anti-Glare, No Transflective] , Pixel Structure [RGB v-stripe]	00	00000000
	118	76	Multi-Media Features [Color Management : NTSC, Dynamic Backlight Control : No]	00	00000000
	119	77	Multi-Media Features [Motion Blur : No support , Active Gamma Control : No support]	00	00000000
	120	78	Special Features [Wireless Enhancement Hardware : No support , In-Cell Scanner : No support]	00	00000000
	121	79	Special Features [Number of LVDS channels or eDP lanes : one , Overdrive : No ,Interface : eDP , In-Cell Touch Support : No]	09	00001001
	122	7A	Special Features [BIST Support : yes , Electronic Privacy : No electronic privacy hardware support , 3-D Support : No]	01	00000001
123	7B	(If<13 char--> 0Ah, then terminate with ASC II code 0Ah,set remaining char = 20h)	0A	00001010	
124	7C	(If<13 char--> 0Ah, then terminate with ASC II code 0Ah,set remaining char = 20h)	20	00100000	
125	7D	(If<13 char--> 0Ah, then terminate with ASC II code 0Ah,set remaining char = 20h)	20	00100000	
Checksum	126	7E	Extension flag (# of optional 128 panel ID extension block to follow, Typ = 0)	00	00000000
	127	7F	Check Sum (The 1-byte sum of all 128 bytes in this panel ID block shall = 0)	D6	11010110